



DIGITAL INSTRUMENTS YOU CAN BUILD

Part 1. Low-Cost Digital Readouts

By DONALD L. STEINBACH

Research Engineer Sr., Lockheed Missiles & Space Co.

Part 1 of a series for those interested in the design and operation of digital-type test instruments or for those who would like to build their own. This article discusses some high-performance, low-cost digital readouts.

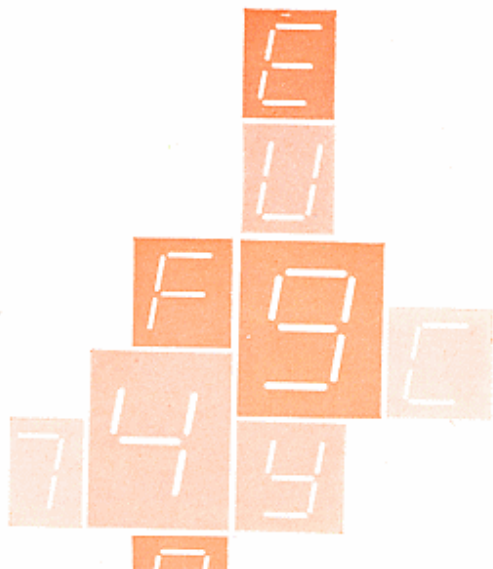

"Digital Instruments You Can Build" is a series of articles for those who want to design and build their own digital test instruments. The series is neither a "take it or leave it" collection of equipment schematics nor a complete course in digital instrument design. It is a group of articles introducing some typical components and subsystems used in digital instruments, and demonstrating at least one design approach to creating each of several items of digital test equipment from these components and subsystems. The reader who is not specifically interested in designing or building digital instruments will find the series a rather painless way of increasing his understanding of how digital instruments function.

The first three articles of this series will deal with low-cost digital readouts, counting and decoding circuits, and integrated circuits, in that order. Treating these rather broad subjects as separate topics early in the series eliminates a good deal of repetitious detail from the equipment-oriented articles to be presented later, and gives the reader a chance to become familiar with some of the key components and subsystems before encountering them as part of a total system.

Various digital instruments will be developed, beginning with the fourth article of the series. The instruments will be introduced in order of increasing complexity or functional relationship, and will include a digital clock, a general-purpose digital event counter, a high-performance digital counter and high-speed prescaler, a d.c. digital voltmeter, an a.c. digital voltmeter, a digital ohmmeter, a digital capacitance meter, and a digital thermometer. Multi-function instruments may, of course, be derived by adding the specialized circuitry from each instrument to a basic "main frame."

Different combinations of digital readouts and associated circuitry are used in each instrument; the various configurations are interchangeable so that the builder has the option of selecting those that best suit his individual requirements. Every effort has been made to achieve an effective balance between cost and performance in all phases of the equipment designs. Comments and suggestions from readers are welcome, and additional items of equipment will be developed if sufficient interest is indicated.

DIGITAL readouts display numerical information directly in digital form rather than in analog measure as is the case with a conventional meter movement. They provide the visual data interface between man and instrument, and should be selected with that thought foremost in the designer's mind. Display devices are available in various forms: electroluminescent panels, cathode-ray display tubes, electro-mechanical display devices, projected image displays, edge-lighted displays, matrix displays, displays using solid-state light sources, numerical indicator tubes, segmented indicator tubes, and segmented indicator modules. Only the latter three types are considered in this article.

Numerical Indicator Tubes

Numerical indicator tubes are gas-filled, cold-cathode tubes functionally related to the familiar neon bulb. They contain at least one anode and a separate cathode for each numeral or character to be displayed.

The individual cathodes are formed in the shapes of the

characters they are to represent and the entire formed cathode glows when voltage is applied between it and the anode. One input lead is required for each character in the tube and (normally) only one lead is energized at any given time.

The characters are perfectly formed, but only those characters included in the tube at the time of manufacture can be displayed. A minimum anode supply voltage of about 170 volts d.c. is required, and the driver circuitry must be capable of switching up to approximately 70 volts d.c. The cathodes are stacked one behind the other, giving the viewer an illusion that the characters are moving toward or away from him, and limiting the maximum viewing angle. Character height is restricted by the practical limitations on the size of the enclosing evacuated glass envelope.

Segmented Indicator Tubes and Modules

Segmented indicator tubes and modules consist of several individual bars or segments lying in a single plane—the usual format is seven individual segments arranged in the form of a block numeral eight (Fig. 1). The desired character is generated by illuminating the combination of segments that most closely duplicates the shape of the intended character. One input lead is required for each segment, and up to seven segments may have to be illuminated simultaneously. The indicator tubes may be incandescent, fluorescent, or cold-cathode gas-filled; the modules usually contain individual incandescent or neon bulbs.

Most of the numerals displayed by these devices are imperfectly formed, but ten numerals, a minus sign, and eleven letters (A, C, E, F, G, H, J, L, P, U, and Y) may be created with a single indicator. Since all segments are in the same

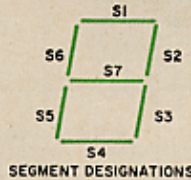

SEGMENT ILLUMINATED	CHARACTER DISPLAYED																				
	1	2	3	4	5	6	7	8	9	0	A	C	E	F	G	H	J	L	P	U	Y
S1	x	x	x	x	x	x	x	x	x	x	x	x	x	x	x	x	x	x	x	x	x
S2	x	x	x	x	x	x	x	x	x	x	x	x	x	x	x	x	x	x	x	x	x
S3	x	x	x	x	x	x	x	x	x	x	x	x	x	x	x	x	x	x	x	x	x
S4	x	x	x	x	x	x	x	x	x	x	x	x	x	x	x	x	x	x	x	x	x
S5	x	x	x	x	x	x	x	x	x	x	x	x	x	x	x	x	x	x	x	x	x
S6	x	x	x	x	x	x	x	x	x	x	x	x	x	x	x	x	x	x	x	x	x
S7	x	x	x	x	x	x	x	x	x	x	x	x	x	x	x	x	x	x	x	x	x

Fig. 1. Diagram showing how seven-segment readout devices are capable of displaying ten numerals (0-9) and eleven letters (A, C, E, F, G, H, J, L, P, U, and Y). Numerals 1, 5, 8, and 0 are used to represent letters I, S, B, and O, respectively.

plane, wide viewing angles are possible. Character height is restricted by the size of the tube envelope, but the size of a module using individual lamps is essentially unrestricted.

Typical Digital Readouts

The general characteristics of some representative digital readouts are summarized in Tables 1, 2, and 3. The vendor data sheets indicated in the "Mfr." column of these tables will be supplied by the manufacturer on request. These sheets provide complete data on the electrical and physical characteristics of each device and should form the basis for any design activity. These readouts will be used in the digital instruments described in future articles, and are selected from among the lines offered by seven manufacturers.

Driver Circuit Fundamentals

The drive circuitry associated with a digital readout must provide for energizing the appropriate numeral or segment while maintaining the readout voltage and current param-

Table 1. Available types, cost, and general characteristics of a number of numerical indicator tubes.

MFR.	TYPE NO.	CHARACTERS DISPLAYED	DIMENSIONS			COST (1-24)	NOTES
			CHARACTER HEIGHT (in) NOMINAL	SEATED HEIGHT MAX. (in)	ENVELOPE DIA. MAX. (in)		
Amperex Electronic Corp. Dist. Sales Dept. Hicksville, N.Y. 11802 Data Sheets on ZM1000/ZM1001 indicator tubes	ZM1000	0-9 and decimal point to left of numerals	0.60	1.670	0.750	\$5.70*	Pins on both tubes resemble those on conventional miniature receiving tubes. May be soldered directly to PC board or used with 14-pin socket (supplied with tubes) that can either be PC board or chassis mounted. Pins are located on 0.100" centers. Tubes have dynamic life expectancy of 200,000 hours.
	ZM1001	"+", "-", "x", "y", "z"	0.60	1.670	0.750	\$7.35*	
Burroughs Corp. Electronic Components Div., Box 1226, Plainfield, N. J. 07061 Bulletins 1061, 1132, and 1153	B-5750	0-9 and decimal points to right and left of numerals	0.515	1.500	0.530	\$6.75	Both tubes have long tinned leads for soldering directly to PC board. Leads are located on various centers (0.090", 0.096", and 0.097"). Combination pin-straightener and standoff is located between bottom of tube envelope and PC board (Fig. 2, left). Tubes have dynamic life expectancy of 200,000 hours under normal d.c. operating conditions.
	B-5856	"+", "-"	0.510	1.350	0.510	\$7.15	
National Electronics Inc., Geneva, Ill. 60134. Data sheets on NL-940 and NL-941 readout tubes	NL-940	0-9 and decimal points to right and left of numerals	0.515	1.500	0.530	\$7.15	Leads are located on 0.090", 0.096", and 0.097" centers and are intended to be soldered directly to PC boards. Both tubes use fairly high standoffs to raise seated height of tube to 1.500" (Fig. 2, right). Dynamic life expectancy is 200,000 hours.
	NL-941	"+", "-"	0.515	1.500	0.530	\$7.15	

*Cost in quantities of 1-99.

MFR.	TYPE NO.	CHARACTERS DISPLAYED	DIMENSIONS			COST (1-99)	NOTES
			CHARACTER HEIGHT (in) NOMINAL	SEATED HEIGHT MAX. (in)	ENVELOPE DIA. MAX. (in)		
Alco Electronic Products, Inc. P.O. Box 1348, Lawrence, Mass. 01842 Catalogue RE-698	MG-17	0-9, "-", and upper left & lower right decimal points	0.433 (max)	1.650	0.413	\$4.95	MG-17 is a seven-segment cold-cathode, gas-filled tube designed for either d.c. or pulsed operation. Decimal point locations allow tube to be used upright or inverted. Colon can be formed by using upper and lower decimal points in two adjacent tubes. Intended to be soldered directly to PC board. MG-19 is a nine-segment neon-readout type.
	MG-19	0-9, "+", "-", and lower right decimal point	0.433 (max)	1.650	0.413	\$4.95	
RCA Electronics Components, P.O. Box 270, Harrison, N. J. 07029. Data sheets on DR2000/DR2010/DR2020/DR2030 digital display devices	DR2010	0-9 and lower left decimal point	0.600	1.625	0.785	\$5.75	Readouts are composed of individual incandescent filaments arranged on a dark background. DR2010 and DR2000 are seven-segment displays. All tubes fit standard 9-pin miniature tube sockets but can be soldered directly to PC board. Do not exhibit filament droop sometimes associated with readouts of this type. Etched glass can be placed in front of display to produce a broader stroke; a Fresnel lens will provide a larger display size. Minimum life expectancy is 100,000 hours.
	DR2020 (Fig. 3, left)	+", "-", and "1"	0.600	1.625	0.785	\$3.25	
	DR2000 (Fig. 3, right)	0-9	0.600	1.625	0.785	\$5.50	
	DR2030	+", "-"	0.600	1.625	0.785	\$3.25	
Tung-Sol Div., Wagner Electric Corp., 630 W. Mt. Pleasant Ave., Livingston, N.J. 07039 Data sheet T438	DT1704B	0-9 or A, C, E, F, G, H, I, J, L, O, P, S, U, and Y	0.570	1.75 (nom.)	0.71 (nom.)	\$5.30	Unique low-voltage vacuum fluorescent devices. They have 1.6 volt (a.c. or d.c.), 45-mA filament; application of 10 to 25 volts d.c. to appropriate anode causes that segment to fluoresce with a blue-green glow. Obvious advantages are low anode voltages and extremely low anode currents. DT1704B is seven-segment readout which fits 9-pin miniature tube socket. DT1705D is seven-segment readout that fits 10-pin miniature socket. DT1707B, a four-segment readout, has a standard 9-pin miniature tube base.
	DT1705D	0-9 and lower right decimal or A, C, E, F, G, H, I, J, L, O, P, S, U, and Y	0.570	1.75 (nom.)	0.71 (nom.)	\$5.75	
	DT1707B	+", "-", "1" and lower right decimal point	0.570	1.75 (nom.)	0.71 (nom.)	\$5.40	

Table 2. Some of the types available, cost, and general characteristics of various segmented indicator tubes.

Fig. 2. Two types of numerical indicator tubes. (Left) Burroughs Type B-5750 and (right) National Electronics Type NL-940. The characteristics for these tubes are given in Table 1.

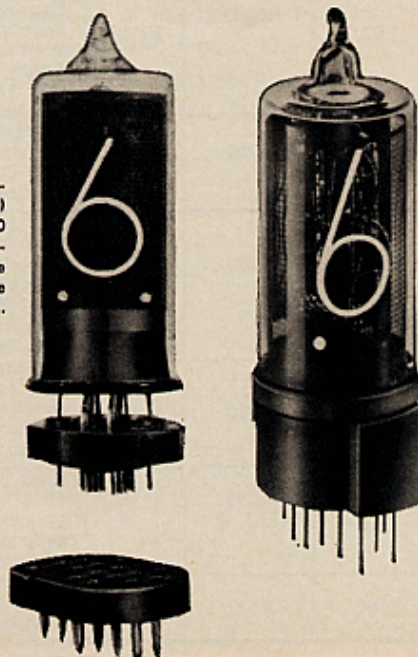

eters within specified limits. The exact configuration of the driver circuitry is a function of the logic control polarity, the readout supply voltage polarity, and the readout operating mode. Five different driver circuit configurations are required to accommodate the readouts described in this article.

Low-voltage incandescent readouts (MS-4000BR, 710-Series, and DR2010/DR2020) consist of either individual lamps or individual lamp filaments. The readout supply voltage can be of either polarity and current limiting is not required. A typical driver circuit uses low-voltage *n-p-n* transistors (Fig. 5A) to complete the return circuit to each segment when a positive voltage is connected to the transistor base resistor.

The low-voltage fluorescent readout (DT1705D/DT1707B) requires the application of a positive voltage to the anode segment to cause that segment to glow; all of the anode segments share a common cathode. The simplest driver circuit supplies a negative voltage to the cathode and grounds the anode through a *p-n-p* transistor when a negative voltage is applied to the transistor base resistor. A more useful driver uses a *p-n-p* transistor in the common-base configuration (Fig. 5B) so that the anode is energized when a positive voltage is applied to the transistor emitter resistor. Note that the emitter source becomes part of the anode return path.

The high-voltage, cold-cathode readout driver circuits must include a current-limiting resistance otherwise the read-

Fig. 3. Two types of segmented indicator tubes. RCA (left) Types DR2020, displaying three characters ("+", "-", and "1") and (right) DR2000, displaying numerals (0-9).

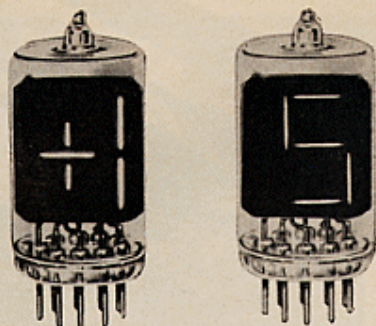

outs will draw excessive current and destroy themselves. They are designed to operate within well defined current limits; the lower limit is that required to maintain a uniform glow discharge; the upper limit restricts electrode erosion and extraneous glow discharge. Permissible operation regions are defined on the applicable device data sheets published by the manufacturers.

Driver circuits for the ZM1000/ZM1001, B-5750/B-5856, and NL-940/NL-941 are similar. The ZM1000 requires a separate decimal point resistor and both the ZM1000 and ZM1001 require a priming resistor (Fig. 6B). The *Burroughs* and *National* devices do not use a separate decimal point resistor (Fig. 6A) unless the decimal point is energized alone. The single anode resistor sets the readout operating current, and its value is a function of the supply voltage.

The MG-17 anode current varies in accordance with the number of cathode segments that are energized, and a single anode resistor cannot be used to establish the tube operating current. Instead, identical resistors are connected to each of

Fig. 4. Two types of segmented indicator modules. Dialight Types (left) 711 caption module, and (right) 710 numeric readout with 1-in character size.

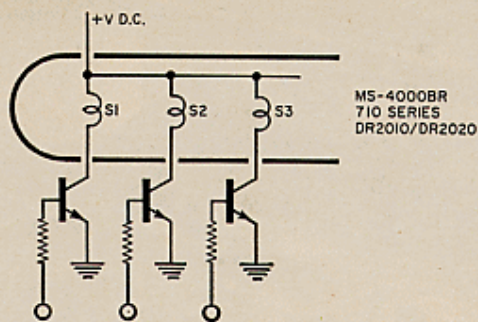
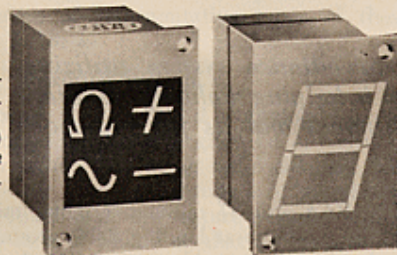

(A)

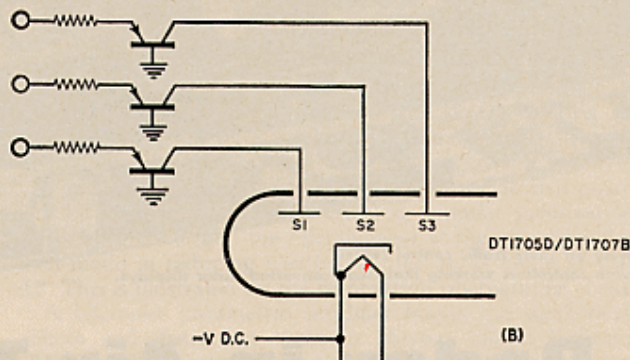

(B)

Fig. 5. Driver circuit configuration for the low-voltage (A) incandescent and (B) fluorescent segmented readouts.

the seven cathode segments to establish their operating current, and higher resistances are connected to the decimal points since their current requirements are lower.

Contrary to what seems to be popular opinion, the driver transistors used with high-voltage, cold-cathode readouts need not withstand the entire supply voltage when the transistor is not conducting. Since at least one cathode is always grounded, the d.c. potential at the anode is established at the tube breakdown or ionization voltage (typically 150 volts d.c. to 180 volts d.c.). The voltage at all extinguished cathodes needs only to be sufficiently positive (*Continued on page 61*)

Table 3. The various types, cost, and general characteristics of some available segmented indicator modules.

MFG.	TYPE	CHARACTERS DISPLAYED	DIMENSIONS				COST (1-99)	NOTES
			CHARACTER HEIGHT (in)	MAX. OVER-ALL MODULE (in)				
				W	H	D		
Alco Electronic Products, Inc. P.O. Box 1348, Lawrence, Mass. 01842. Catalogue RE-698	MS-4000 BR	0-9	0.614	0.562	1.184	1.412	\$6.93	Seven-segment incandescent readout modules. Red filter, bulbs, and socket are included in price. Each segment requires 40-60 mA at 3-5 volts d.c.
Dialight Corp., 60 Stewart Ave., Brooklyn, N. Y. 11237. Catalogue L-181	710-0300-005	0-9	1.000	1.250	1.750	1.506	\$6.79	Modules (Fig. 4) do not include lamps, but suitable 6, 10, 14-16, and 24-28 volt incandescent lamps and 160-volt neon lamps are available from Dialight and other sources. No. 344 bulbs are used for 14-16 volt operation even though normally considered a 10-volt, 14-mA bulb. When operated at 16 volts, No. 344 bulb will last well in excess of 100,000 hours average life claimed in data sheet. No. 344 bulb available from Dialight for 55 cents each.
	710-0301-005	0-9, lower right decimal	1.000	1.250	1.750	1.506	\$7.79	
	710-0302-005	0-9, upper left decimal	1.000	1.250	1.750	1.506	\$7.79	
	711-1855 caption module*	•	•	1.250	1.750	1.506		

*Module provides a backlighted transparency that displays an explanatory caption. Lighted area may present a single message or may be divided into 2, 3, 4, or 6 individually switchable areas. For example, by using four separate sections, plus and minus signs may be presented one above the other, leaving two other areas for symbols or words (Fig. 4, left).

Digital Instruments You Can Build

(Continued from page 31)

(approximately 70 volts d.c.) to assure that a glow discharge cannot be sustained on the "off" cathodes. Thus, a transistor having a collector-to-emitter breakdown voltage in excess of 70 volts will serve adequately as a driver.

It is interesting to note that the driver transistor collector will usually be pulled up into the breakdown region because of the few microamperes of current drawn by the "off" cathode. This is permissible as long as the transistor power dissipation ratings are not exceeded and a stable operating point can be maintained.

Availability

New readouts are being introduced almost daily. The readouts described in this article are, in the author's opinion, those offering the greatest performance at the least cost. Understandably, these readouts will not be obtainable from the corner electronics store, or even from the major mail-order distributors. However, the components *are* available, and the reader should contact the manufacturers indicated in the tables to obtain the relevant data sheets and the name of the nearest distributor.

Prices

Prices of the readouts are given in the tables *for information only*. It must be understood that the stated prices are correct as of the date this article was written, but are subject to change without notice. Before a particular design is discarded on the basis of price alone, the reader should obtain current prices. Based on recent industry trends, prices are more likely to decrease than increase.

Next month's article will describe various counting and

decoding circuits compatible with either segmented or numerical display devices. (Continued Next Month)

Fig. 6. Driver circuit configurations for (A) Burroughs B-5750 and B-5856 and National's NL-940 and NL-941 devices that do not require separate decimal-point resistor unless the decimal point is energized alone and for (B) Amprex Types ZM1000 and ZM1001 which require a priming resistor. Type ZM1000 also requires separate decimal-point resistor.

